

Approval body for construction products  
and types of construction

Bautechnisches Prüfamt

An institution established by the Federal and  
Laender Governments



## European Technical Assessment

ETA-22/0704  
of 28 October 2022

English translation prepared by DIBt - Original version in German language

### General Part

Technical Assessment Body issuing the  
European Technical Assessment:

Deutsches Institut für Bautechnik

Trade name of the construction product

Injection system EJOT Multifix USF /  
Sormat ITH-Ve for rebar connection

Product family  
to which the construction product belongs

Systems for post-installed  
rebar connections with mortar

Manufacturer

EJOT SE & Co. KG  
MU Construction  
In der Stockwiese 35  
57334 Bad Laasphe  
DEUTSCHLAND

Manufacturing plant

EJOT Herstellwerk 24

This European Technical Assessment  
contains

22 pages including 3 annexes which form an integral part  
of this assessment

This European Technical Assessment is  
issued in accordance with Regulation (EU)  
No 305/2011, on the basis of

EAD 330087-01-0601, Edition 06/2021

The European Technical Assessment is issued by the Technical Assessment Body in its official language. Translations of this European Technical Assessment in other languages shall fully correspond to the original issued document and shall be identified as such.

Communication of this European Technical Assessment, including transmission by electronic means, shall be in full. However, partial reproduction may only be made with the written consent of the issuing Technical Assessment Body. Any partial reproduction shall be identified as such.

This European Technical Assessment may be withdrawn by the issuing Technical Assessment Body, in particular pursuant to information by the Commission in accordance with Article 25(3) of Regulation (EU) No 305/2011.

**Specific Part**

**1 Technical description of the product**

The subject of this European Technical Assessment is the post-installed connection, by anchoring or overlap connection joint, of reinforcing bars (rebars) in existing structures made of normal weight concrete, using the "Injection system EJOT Multifix USF / Sormat ITH-Ve for rebar connection" in accordance with the regulations for reinforced concrete construction.

Reinforcing bars made of steel with a diameter  $\phi$  from 8 to 32 mm or the tension anchor ZA from sizes M12 to M24 according to Annex A and mortar EJOT Multifix USF / Sormat ITH-Ve are used for rebar connections. The rebar is placed into a drilled hole filled with injection mortar and is anchored via the bond between rebar, injection mortar and concrete.

The product description is given in Annex A.

**2 Specification of the intended use in accordance with the applicable European assessment Document**

The performances given in Section 3 are only valid if the rebar connection is used in compliance with the specifications and conditions given in Annex B.

The verifications and assessment methods on which this European Technical Assessment is based lead to the assumption of a working life of the rebar connection of at least 50 years. The indications given on the working life cannot be interpreted as a guarantee given by the producer, but are to be regarded only as a means for choosing the right products in relation to the expected economically reasonable working life of the works.

**3 Performance of the product and references to the methods used for its assessment**

**3.1 Mechanical resistance and stability (BWR 1)**

Essential characteristic	Performance
Characteristic resistance under static and quasi-static loading	See Annex C 1
Characteristic resistance under seismic loading	No performance assessed

**3.2 Safety in case of fire (BWR 2)**

Essential characteristic	Performance
Reaction to fire	Class A1
Resistance to fire	See Annex C 2 and C 3

**4 Assessment and verification of constancy of performance (AVCP) system applied, with reference to its legal base**

In accordance with European Assessment Document EAD No. 330087-01-0601, the applicable European legal act is: [96/582/EC].

The system(s) to be applied is (are): 1

**5 Technical details necessary for the implementation of the AVCP system, as provided for in the applicable European Assessment Document**

Technical details necessary for the implementation of the AVCP system are laid down in the control plan deposited with Deutsches Institut für Bautechnik.

Issued in Berlin on 28 October 2022 by Deutsches Institut für Bautechnik

Dipl.-Ing. Beatrix Wittstock  
Head of Section

*beglaubigt:*  
Baderschneider

### Installation post installed rebar

**Figure A1:** Overlapping joint for rebar connections of slabs and beams

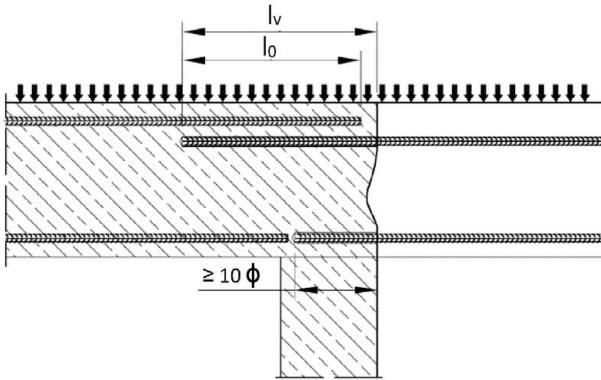

**Figure A3:** End anchoring of slabs or beams (e.g. designed as simply supported)

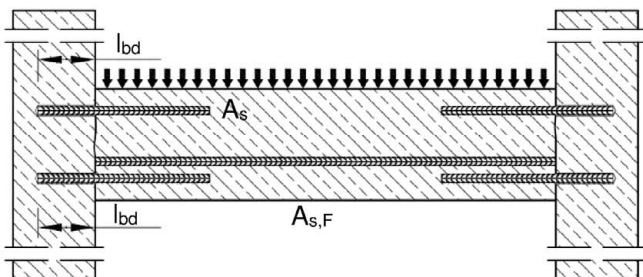

**Figure A5:** Anchoring of reinforcement to cover the line of acting tensile force

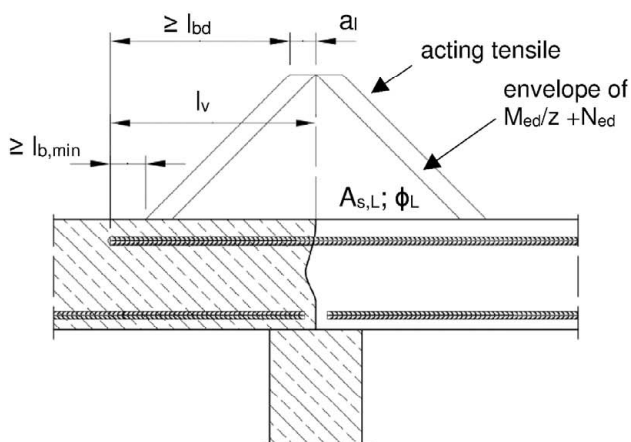

**Figure A2:** Overlapping joint at a foundation of a wall or column where the rebars are stressed in tension

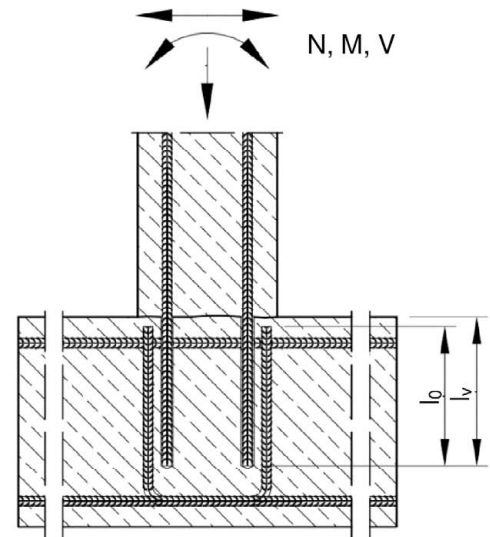

**Figure A4:** Rebar connection for components stressed primarily in compression.

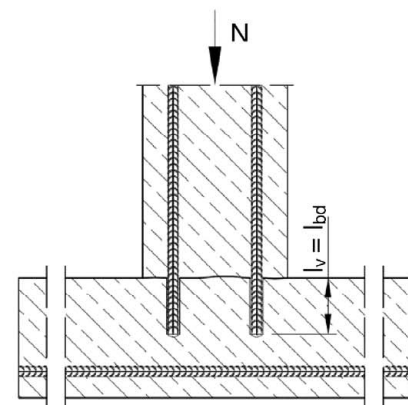

**Note to Figure A1 to A5:**

In the Figures no transverse reinforcement is plotted, the transverse reinforcement shall comply with EN 1992-1-1:2004+AC:2010.

Preparing of joints according to Annex B 2

Injection system EJOT Multifix USF / Sormat ITH-Ve for rebar connection

**Product description**

Installed condition and examples of use for rebars

**Annex A 1**

## Installation tension anchor ZA

**Figure A6:** Anchorage of column to foundation with tension anchor ZA.

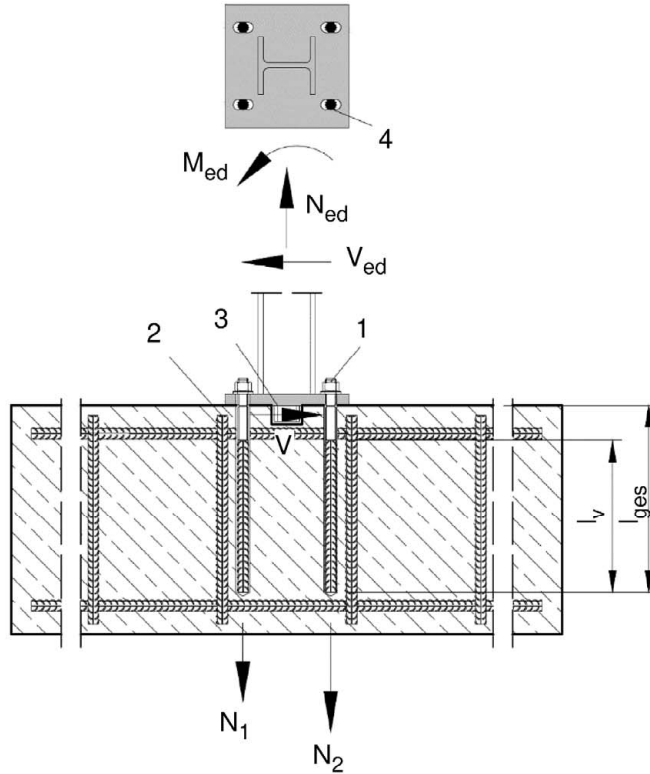

- 1 Tension anchor ZA (tension only)
- 2 Existing stirrup / reinforcement for overlap (lap splice)
- 3 Shear lug (or fastener loaded in shear)
- 4 Slotted hole with axial direction to the shear force

**Figure A7:** Anchorage of guardrail posts or cantilevered building components with tension anchor ZA and fastener.

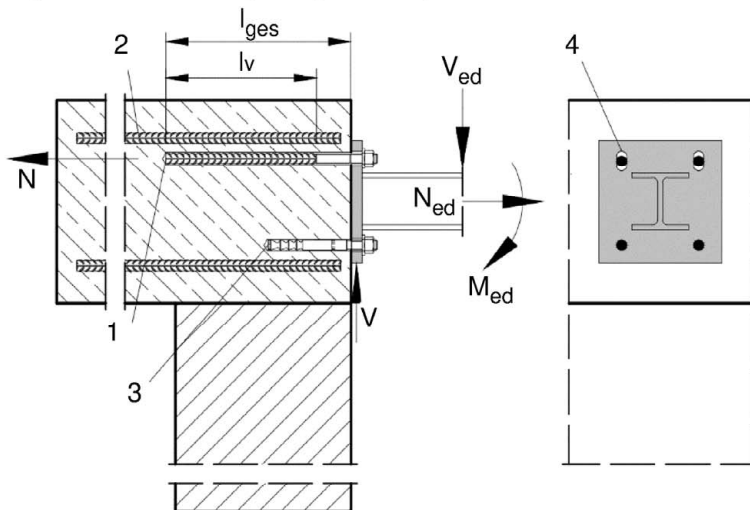

- 1 Tension anchor ZA (tension only)
- 2 Existing stirrup / reinforcement for overlap (lap splice)
- 3 Fastener (or shear lug loaded in shear)
- 4 Slotted hole with axial direction to the shear force

**Note to Figure A6 and A7:** In the Figures no transverse reinforcement is plotted, the transverse reinforcement shall comply with EN 1992-1-1:2004+AC:2010. The tension anchor may be only used for axial tensile force. The tensile force must be transferred by lap to the existing reinforcement of the building. The transfer of the shear force has to be ensured by suitable measures, e.g. by means of shear lugs or anchors with European Technical Assessment (ETA). General construction rules see Annex B 3

**Injection system EJOT Multifix USF / Sormat ITH-Ve for rebar connection**

**Product description**

Installed condition and examples of use for tension anchors ZA

**Annex A 2**

## Cartridge system

### Coaxial Cartridge

150 ml, 280 ml, 300 ml up to 333 ml and 380 ml up to 420 ml

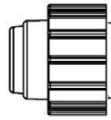

**Imprint:**

**EJOT Multifix USF / Sormat ITH-Ve**

Processing and safety instructions, shelf life, charge number, manufacturer's information, quantity information

### Side-by-Side Cartridge:

235 ml, 345 ml up to 360 ml and 825 ml

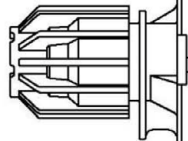

**Imprint:**

**EJOT Multifix USF / Sormat ITH-Ve**

Processing and safety instructions, shelf life, charge number, manufacturer's information, quantity information

### Foil tube Cartridge:

165 ml and 300 ml

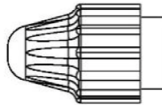

**Imprint:**

**EJOT Multifix USF / Sormat ITH-Ve**

Processing and safety instructions, shelf life, charge number, manufacturer's information, quantity information

### Static mixer SM-14W

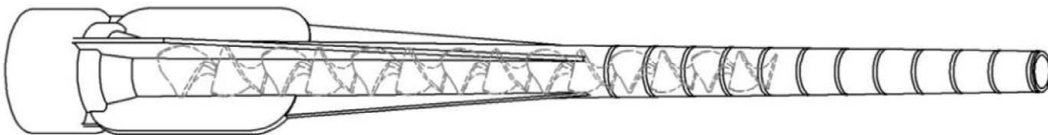

### Static mixer PM-19E

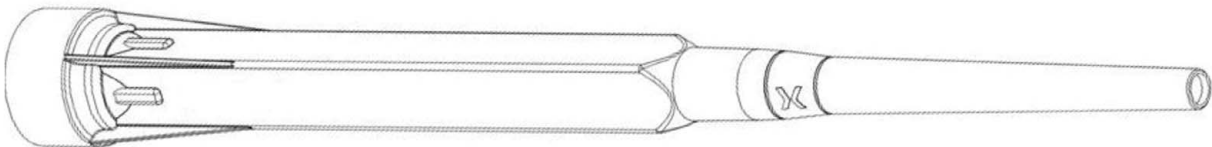

### Piston plug VS and mixer extension VL



Injection system EJOT Multifix USF / Sormat ITH-Ve for rebar connection

**Product description**

Injection system

**Annex A 3**

### Reinforcing bar (rebar): $\varnothing 8$ up to $\varnothing 32$

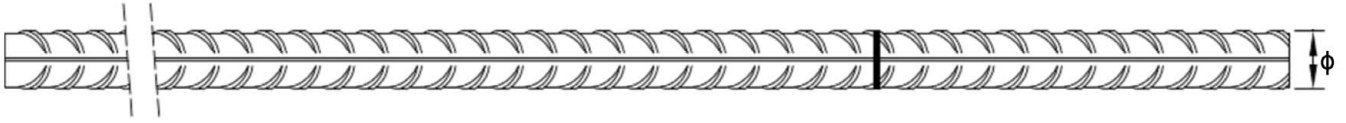

- Minimum value of related rip area  $f_{R,min}$  according to EN 1992-1-1:2004+AC:2010
- Rib height of the bar shall be in the range  $0,05\phi \leq h_{rib} \leq 0,07\phi$   
( $\phi$ : Nominal diameter of the bar;  $h_{rib}$ : Rib height of the bar)

**Table A1: Materials Rebar**

Designation	Material
Rebar EN 1992-1-1:2004+AC:2010, Annex C	Bars and de-coiled rods class B or C $f_{yk}$ and $k$ according to NDP or NCI of EN 1992-1-1/NA $f_{uk} = f_{tk} = k \cdot f_{yk}$

**Injection system EJOT Multifix USF / Sormat ITH-Ve for rebar connection**

**Product description**  
Specifications Rebar

**Annex A 4**



### Tension Anchor: ZA-M12 up to ZA-M24

Marking: e.g.  12 A4

-  Mark of the producer
- ZA Trade name
- 12 Rod diameter/thread
- A4 for stainless steel A4
- HCR for high corrosion resistance steel

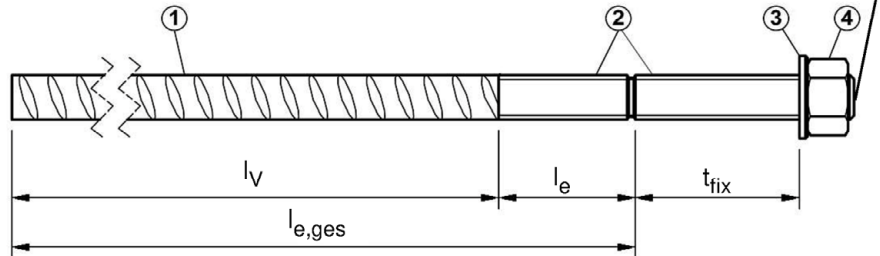

**Table A2: Materials Tension Anchor ZA**

Part	Designation	Material											
		ZA vz				ZA A4				ZA HCR			
		M12	M16	M20	M24	M12	M16	M20	M24	M12	M16	M20	M24
1	Reinforcement bar	Class B according to NDP or NCI of EN 1992-1-1/NA $f_{uk} = f_{tk} = k \cdot f_{yk}$											
	$f_{yk}$ [N/mm <sup>2</sup> ]	500				500				500			
2	Threaded rod	Steel, zinc plated according to EN ISO 683-4:2018 or EN 10263:2001				Stainless steel, 1.4362, 1.4401, 1.4404, 1.4571, EN 10088-1:2014				High corrosion resistant steel, 1.4529, 1.4565, EN 10088-1:2014			
3	Washer	Steel, zinc plated according to EN ISO 683-4:2018 or EN 10263:2001				Stainless steel, 1.4362, 1.4401, 1.4404, 1.4571, EN 10088-1:2014				High corrosion resistant steel, 1.4529, 1.4565, EN 10088-1:2014			
4	Nut												

**Table A3: Dimensions and installation parameters**

Size			ZA-M12	ZA-M16	ZA-M20	ZA-M24	
Diameter of threaded rod	$d_s$	[mm]	12	16	20	24	
Diameter of reinforcement bar	$\phi$	[mm]	12	16	20	25	
Drill hole diameter	$d_o$	[mm]	16	20	25	32	
Diameter of clearance hole in fixture	$d_f$	[mm]	14	18	22	26	
With across nut flats	SW	[mm]	19	24	30	36	
Stress area	$A_s$	[mm <sup>2</sup> ]	84	157	245	353	
Effective embedment depth	$l_v$	[mm]	according to static calculation				
Length of bonded thread	plated	$l_e$	[mm]	≥ 20	≥ 20	≥ 20	≥ 20
	A4/HCR			≥ 100	≥ 100	≥ 100	≥ 100
Minimum thickness of fixture	min $t_{fix}$	[mm]	5	5	5	5	
Maximum thickness of fixture	max $t_{fix}$	[mm]	3000	3000	3000	3000	
Maximum installation torque	max $T_{inst}$	[Nm]	50	100	150	150	

**Injection system EJOT Multifix USF / Sormat ITH-Ve for rebar connection**

**Product description**  
Specifications Tension Anchor ZA

**Annex A 5**

<b>Specification of the intended use</b>			
<b>Anchorage subject to:</b>		Working life 50 years	Working life 100 years
HD: Hammer drilling HDB: Hammer drilling with hollow drill bit CD: Compressed air drilling	static and quasi-static loads	Ø8 to Ø32 ZA-M12 to ZA-M24	No performance assessed
	seismic action	No performance assessed	No performance assessed
	Fire exposure	Ø8 to Ø32 ZA-M12 to ZA-M24	No performance assessed
Temperature Range:	- 40°C to +80°C (max long-term temperature +50 °C and max short-term temperature +80 °C)		
<b>Base materials:</b> <ul style="list-style-type: none"> <li>- Reinforced or unreinforced normal weight concrete according to EN 206:2013 + A1:2016.</li> <li>- Strength classes C12/15 to C50/60 according to EN 206:2013 + A1:2016.</li> <li>- Maximum chloride content of 0,40% (CL 0.40) related to the cement content according to EN 206:2013 + A1:2016.</li> <li>- Non-carbonated concrete.</li> </ul> <p>Note: In case of a carbonated surface of the existing concrete structure the carbonated layer shall be removed in the area of the post-installed rebar connection with a diameter of <math>\phi + 60</math> mm prior to the installation of the new rebar.</p> <p>The depth of concrete to be removed shall correspond to at least the minimum concrete cover in accordance with EN 1992-1-1:2004+AC:2010. The foregoing may be neglected if building components are new and not carbonated and if building components are in dry conditions.</p>			
<b>Use conditions (Environmental conditions) with tension anchor ZA:</b> <ul style="list-style-type: none"> <li>- Structures subject to dry internal conditions (all materials).</li> <li>- For all other conditions according to EN 1993-1-4:2006+A1:2015 corresponding to corrosion resistance class:                             <ul style="list-style-type: none"> <li>• Stainless steel Stahl A4 according to Annex A 4, Table A1: CRC III</li> <li>• High corrosion resistance steel HCR according to Annex A 4, Table A1: CRC V</li> </ul> </li> </ul>			
<b>Design:</b> <ul style="list-style-type: none"> <li>- Anchorages are designed under the responsibility of an engineer experienced in anchorages and concrete work.</li> <li>- Verifiable calculation notes and drawings are prepared taking account of the forces to be transmitted.</li> <li>- Design according to EN 1992-1-1:2004+AC:2010, EN 1992-1-2:2004+AC:2008 and Annex B 2 and B 3.</li> <li>- The actual position of the reinforcement in the existing structure shall be determined on the basis of the construction documentation and taken into account when designing.</li> </ul>			
<b>Installation:</b> <ul style="list-style-type: none"> <li>- Dry or wet concrete. It must not be installed in flooded holes.</li> <li>- Overhead installation allowed.</li> <li>- Hole drilling by hammer drill (HD), hollow drill (HDB) or compressed air drill mode (CD).</li> <li>- The installation of post-installed rebar resp. tension anchors shall be done only by suitable trained installer and under supervision on site; the conditions under which an installer may be considered as suitable trained and the conditions for supervision on site are up to the Member States in which the installation is done.</li> <li>- Check the position of the existing rebars (if the position of existing rebars is not known, it shall be determined using a rebar detector suitable for this purpose as well as on the basis of the construction documentation and then marked on the building component for the overlap joint).</li> </ul>			
<b>Injection system EJOT Multifix USF / Sormat ITH-Ve for rebar connection</b>			<b>Annex B 1</b>
<b>Intended use Specifications</b>			

**Figure B1: General construction rules for post-installed rebars**

- Only tension forces in the axis of the rebar may be transmitted.
- The transfer of shear forces between new concrete and existing structure shall be designed additionally according to EN 1992-1-1:2004+AC:2010.
- The joints for concreting must be roughened to at least such an extent that aggregate protrude.

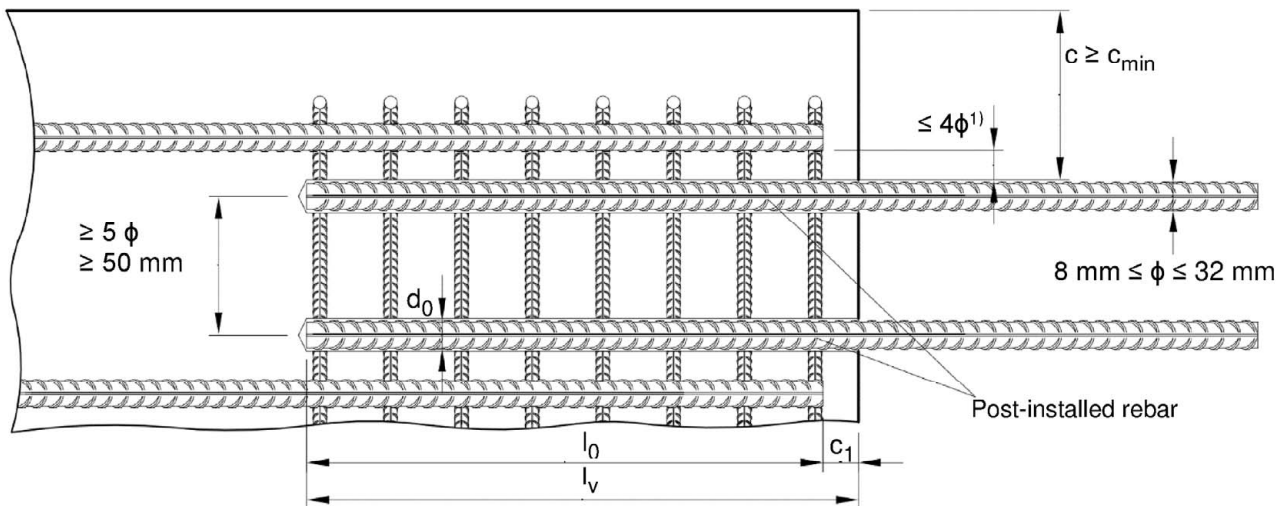

1) If the clear distance between lapped bars exceeds  $4\phi$ , then the lap length shall be increased by the difference between the clear bar distance and  $4\phi$ .

The following applies to Figure B1:

- $c$  concrete cover of post-installed rebar
- $c_1$  concrete cover at end-face of existing rebar
- $c_{\min}$  minimum concrete cover according to Table B1 and to EN 1992-1-1:2004+AC:2010, Section 4.4.1.2
- $\phi$  diameter of post-installed rebar
- $l_0$  lap length, according to EN 1992-1-1:2004+AC:2010, Section 8.7.3
- $l_v$  effective embedment depth,  $\geq l_0 + c_1$
- $d_0$  nominal drill bit diameter, see Annex B 5

**Injection system EJOT Multifix USF / Sormat ITH-Ve for rebar connection**

**Intended use**  
General construction rules for post-installed rebars

**Annex B 2**

**Figure B2: General construction rules for tension anchors ZA**

- The length of the bonded-in thread may be not be accounted as anchorage.
- Only tension forces in the direction of the bar axis may be transmitted by the tension anchor ZA.
- The tension force must be transferred via an overlap joint to the reinforcement in the building part.
- The transfer of shear forces shall be ensured by appropriate additional measures, e.g shear lugs or by anchors with an European technical assessment.
- In the anchor plate, the holes for the tension anchors shall be executed as elongated holes with axis in the direction of the shear force.

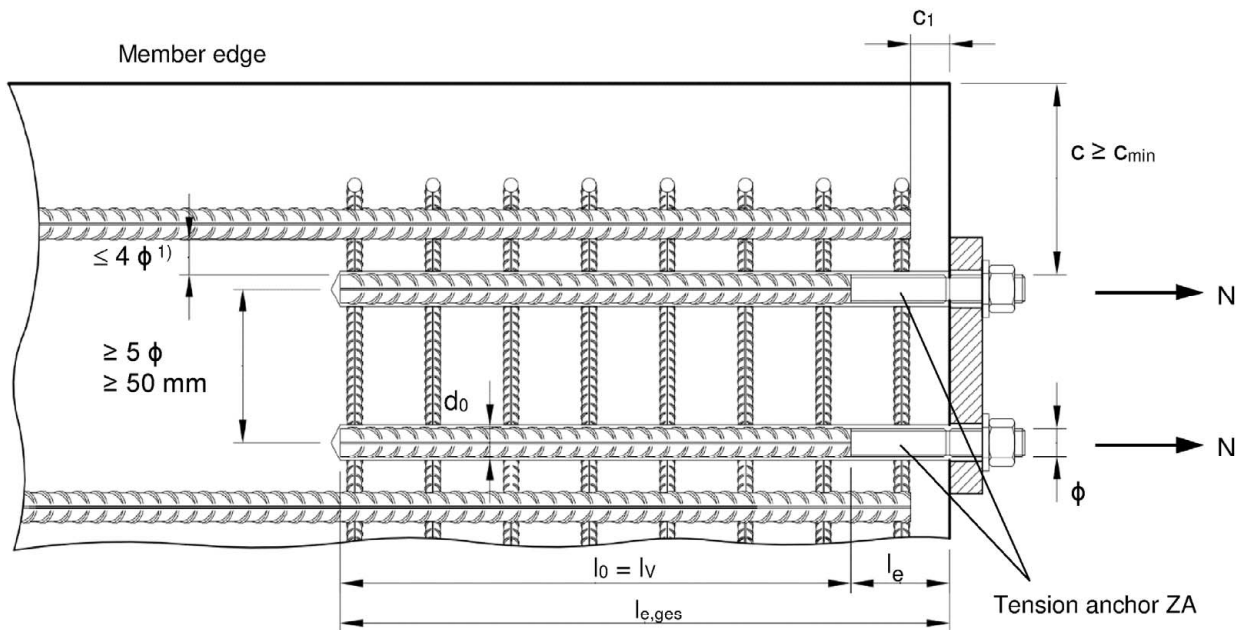

1) If the clear distance between lapped bars exceeds  $4\phi$ , then the lap length shall be increased by the difference between the clear bar distance and  $4\phi$ .

The following applies to Figure B2:

$c$	concrete cover of tension anchor ZA
$c_1$	concrete cover at end-face of existing rebar
$c_{min}$	minimum concrete cover according to Table B1 and to EN 1992-1-1:2004+AC:2010, Section 4.4.1.2
$\phi$	diameter of tension anchor
$l_0$	lap length, according to EN 1992-1-1:2004+AC:2010, Section 8.7.3
$l_v$	effective embedment depth
$l_e$	Length of bonded thread
$l_{e,ges}$	overall embedment depth, $\geq l_0 + c_2$
$d_0$	nominal drill bit diameter, see Annex B 5

**Injection system EJOT Multifix USF / Sormat ITH-Ve for rebar connection**

**Intended use**

General construction rules for tension anchors ZA

**Annex B 3**



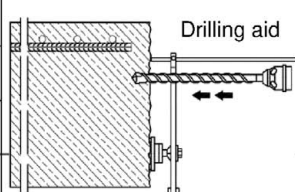





**Table B1: Minimum concrete cover  $c_{\min}^{1)}$  of post-installed rebar and tie rod ZA depending of drilling method**

Drilling method	Rebar diameter	Without drilling aid	With drilling aid	
Hammer drilling (HD) Hammer drilling with hollow drill (HDB)	< 25 mm	$30 \text{ mm} + 0,06 \cdot l_v \geq 2 \phi$	$30 \text{ mm} + 0,02 \cdot l_v \geq 2 \phi$	
	$\geq 25 \text{ mm}$	$40 \text{ mm} + 0,06 \cdot l_v \geq 2 \phi$	$40 \text{ mm} + 0,02 \cdot l_v \geq 2 \phi$	
Compressed air drilling (CD)	< 25 mm	$50 \text{ mm} + 0,08 \cdot l_v$	$50 \text{ mm} + 0,02 \cdot l_v$	
	$\geq 25 \text{ mm}$	$60 \text{ mm} + 0,08 \cdot l_v \geq 2 \phi$	$60 \text{ mm} + 0,02 \cdot l_v \geq 2 \phi$	

<sup>1)</sup> see Annex B 2, Figure B1 and Annex B 3, Figure B2

Comments: The minimum concrete cover acc. EN 1992-1-1:2004+AC:2010 must be observed.

**Table B2: Dispensing tools**

Cartridge type/size	Hand tool		Pneumatic tool
Coaxial cartridges and foil tube cartridges 150, 165, 280, 300 up to 333 ml	 e.g. Type H297 / H244C		 e.g. Type TS 492 X
Coaxial cartridges 380 up to 420 ml	 e.g. Type CCM 380/10	 e.g. Type H 285 or H244C	 e.g. Type TS 485 LX
Side-by-side cartridges 235, 345 ml	 e.g. Type CBM 330A	 e.g. Type H 260	 e.g. Type TS 477 LX
Side-by-side cartridge 825 ml	-	-	 e.g. Type TS 498X

All cartridges could also be extruded by a battery tool.

**Injection system EJOT Multifix USF / Sormat ITH-Ve for rebar connection**

**Intended use**  
Minimum concrete cover  
Dispensing tools

**Annex B 4**

**Table B3: Brushes, piston plugs, max anchorage depth and mixer extension, hollow drill bit system (HDB), hammer (HD) and compressed air (CD) drilling**

Bar size - $\phi$	Tension Anchor - $\phi$	Drill bit - $\emptyset$		$d_b$ Brush - $\emptyset$	$d_{b,min}$ min. Brush - $\emptyset$	Piston plug	Cartridge: All sizes				Cartridge: 825 ml					
		HD HDB	CD				Hand or battery tool		Pneumatic tool		Pneumatic tool					
							$l_{v,max}$	Mixer extension	$l_{v,max}$	Mixer extension	$l_{v,max}$	Mixer extension				
[mm]	[mm]	[mm]		[mm]	[mm]		[mm]		[mm]		[mm]					
8	-	10	-	RBT10	12	10,5	-	250	VL10/0,75 or VL16/1,8	250	VL10/0,75 or VL16/1,8	250	VL10/0,75 or VL16/1,8			
	-			RBT12	14	12,5	-	700		800		800				
10	-	12	-	RBT14	16	14,5	VS14	250		250		250		250	250	
	-							700		1000		1000		1000		
12	ZA-M12	14	-	RBT16	18	16,5	VS16	250		250		250		250	250	
14	-	16	-					RBT18		20		18,5		VS18	700	1000
	16	ZA-M16	18	-	RBT20	22	20,5	VS20		700		1000		1000	1400	
20		ZA-M20	20	-	RBT25	27	25,5	VS25		500		VL10/0,75 or VL16/1,8		700	VL10/0,75 or VL16/1,8	1600
	-		26	RBT26	28	26,5	VS25	2000								
22	-	28	-	RBT28	30	28,5	VS28	500		700		700		2000		
24/25	ZA-M24	32	-	RBT32	34	32,5	VS32	500	500	500	1000					
28	-	35	-	RBT35	37	35,5	VS35	500	500	500	1000					
32	-	40	-	RBT40	41,5	40,5	VS40	500	500	500	1000					

### Cleaning and installation tools

#### Hand pump

(Volume 750 ml,  $h_0 \geq 10 d_s$ ,  $d_0 \leq 20\text{mm}$ )



#### Manual slide valve

(min 6 bar)



#### Brush RBT



#### Piston Plug VS

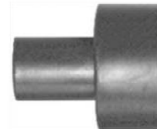

#### Brush extension RBL



Injection system EJOT Multifix USF / Sormat ITH-Ve for rebar connection

#### Intended Use

Parameter brushes, piston plugs, max anchorage depth and mixer extension  
Cleaning and installation tools

Annex B 5

**Table B4: Working time and curing time**

Temperature in base material			Maximum working time	Minimum curing time <sup>1)</sup>
T			$t_{\text{work}}$	$t_{\text{cure}}$
- 10 °C	up to	- 6 °C	90 min <sup>2)</sup>	24 h
- 5 °C	up to	- 1 °C	90 min <sup>3)</sup>	14 h
0 °C	up to	+ 4 °C	45 min <sup>3)</sup>	7 h
+ 5 °C	up to	+ 9 °C	25 min <sup>3)</sup>	2 h
+ 10 °C	up to	+ 19 °C	15 min <sup>3)</sup>	80 min
+ 20 °C	up to	+ 24 °C	6 min <sup>3)</sup>	45 min
+ 25 °C	up to	+ 29 °C	4 min <sup>3)</sup>	25 min
+ 30 °C	up to	+ 40 °C	2,5 min <sup>4)</sup>	15 min
Cartridge temperature			+5°C up to +40°C	

- 1) The minimum curing time is only valid for dry base material.  
In wet base material the curing time must be doubled.
- 2) Cartridge temperature must be at least +15°C
- 3) Cartridge temperature must be between +5°C and +25°C
- 4) Cartridge temperature must be below +20°C

**Injection system EJOT Multifix USF / Sormat ITH-Ve for rebar connection**

**Intended Use**  
Working and curing time

**Annex B 6**

## Installation instructions

**Attention: Before drilling, remove carbonated concrete and clean contact areas (see Annex B1)  
In case of aborted drill hole: the drill hole shall be filled with mortar.**

### Drilling of the bore hole

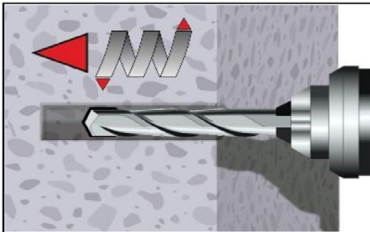

**1a. Hammer drilling (HD) / Compressed air drilling (CD)**

Drill a hole to the required embedment depth.  
Drill bit diameter according to Table B3.  
Proceed with Step 2 (MAC or CAC).

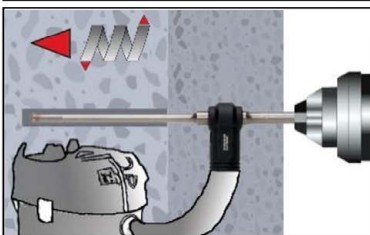

**1b. Hollow drill bit system (HDB)**

Drill a hole to the required embedment depth.  
Drill bit diameter according to Table B3.  
Proceed with Step 2 (MAC or CAC).

### Manual Air Cleaning (MAC)

for drill hole diameter  $d_0 \leq 20\text{mm}$  and drill hole depth  $h_0 \leq 10\phi$  with drilling method HD, HDB and CD

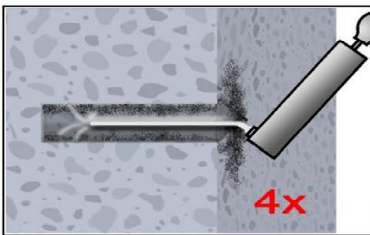

**Attention! Standing water in the bore hole must be removed before cleaning.**

**2a.** Blow the bore hole clean minimum 4x from the bottom or back by hand pump (Annex B 5).

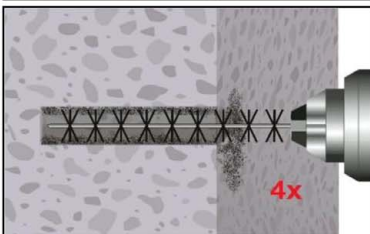

**2b.** Brush the bore hole minimum 4x with brush RBT according to Table B3 over the entire embedment depth in a twisting motion (if necessary, a brush extension RBL shall be used).

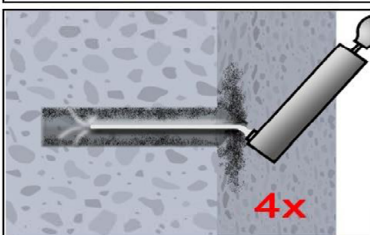

**2c.** Finally blow the bore hole clean minimum 4x from the bottom or back by hand pump (Annex B 5).

**Injection system EJOT Multifix USF / Sormat ITH-Ve for rebar connection**

**Intended Use**  
Installation instruction

**Annex B 7**



**Installation instructions (continuation)**

**Compressed Air Cleaning (CAC):**

All diameter with drilling method HD, HDB and CD

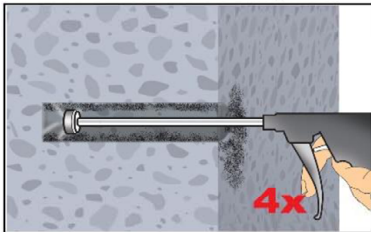

**Attention! Standing water in the bore hole must be removed before cleaning.**

**2a.** Blow the bore hole clean minimum 4x with compressed air (min. 6 bar) (Annex B 5) over the entire embedment depth until return air stream is free of noticeable dust. (If necessary, an extension shall be used.)

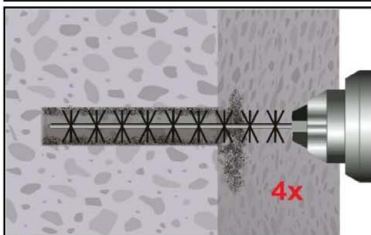

**2b.** Brush the bore hole minimum 4x with brush RBT according to Table B3 over the entire embedment depth in a twisting motion (If necessary, a brush extension RBL shall be used.).

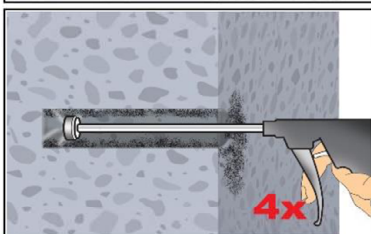

**2c.** Finally blow the bore hole clean minimum 4x with compressed air (min. 6 bar) (Annex B 5) over the entire embedment depth until return air stream is free of noticeable dust. (If necessary, an extension shall be used.).

**Protect cleaned bore hole against re-contamination in an appropriate way. If necessary, repeat cleaning process directly before dispensing the mortar. In-flowing water must not contaminate the bore hole again.**

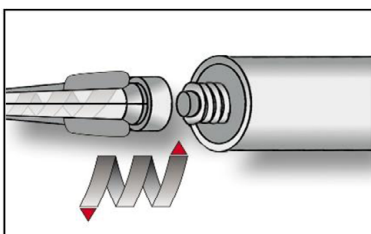

**3.** Screw on static-mixing nozzle SM-14W or PM-19E, and load the cartridge into an appropriate dispensing tool. Cut off the foil tube clip before use. For every working interruption longer than the maximum working time  $t_{work}$  (Annex B 6) as well as for new cartridges, a new static-mixer shall be used.

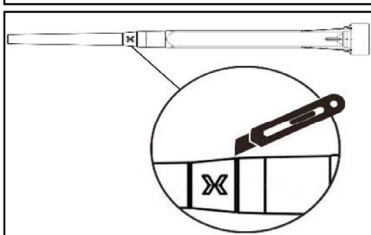

**3a.** In case of using the mixer extension VL16/1,8 cut off the tip of the mixer nozzle PM-19E at position „X“.

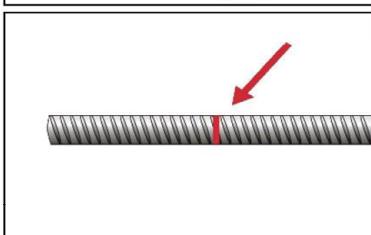

**4.** Mark embedment depth on the reinforcing bar. The reinforcing bar shall be free of dirt, grease, oil or other foreign material.

**Injection system EJOT Multifix USF / Sormat ITH-Ve for rebar connection**

**Intended Use**  
Installation instruction (continuation)

**Annex B 8**

### Installation instructions (continuation)

5. Mark mixer nozzle and extension with mortar level mark  $l_m$  and anchorage depth  $l_v$  resp.  $l_{e,ges}$

Quick estimation:  $l_m = 1/3 \cdot l_v$

Optimum mortar volume:

$$l_m = l_v \text{ bzw. } l_{e,ges} \cdot \left( 1,2 \cdot \frac{\phi^2}{d_0^2} - 0,2 \right)$$

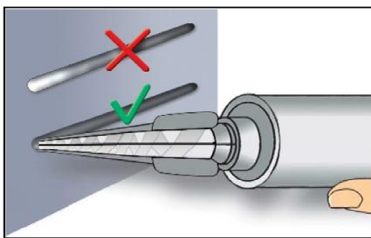
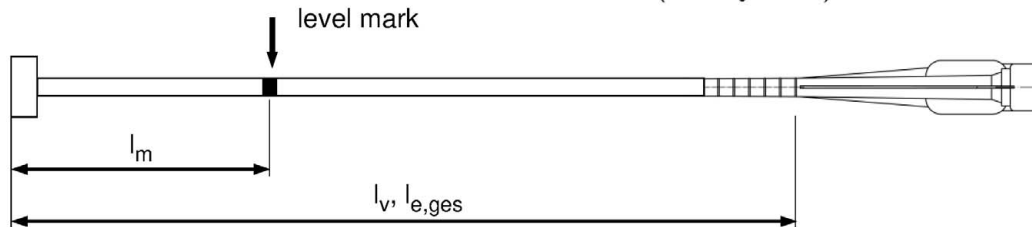

6. Not proper mixed mortar is not sufficient for fastening.  
Dispense and discard mortar until an uniform grey colour is shown, at least 3 full strokes. For foil tube cartridges it must be discarded a minimum of 6 full strokes.

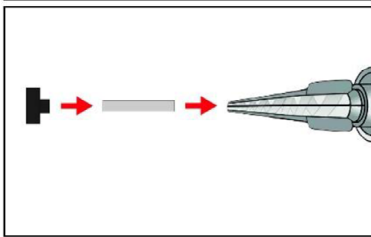

7. Piston plugs VS and mixer nozzle extensions VL shall be used according to Table B3.  
Assemble mixing nozzle, mixer extension and piston plug before injecting mortar.

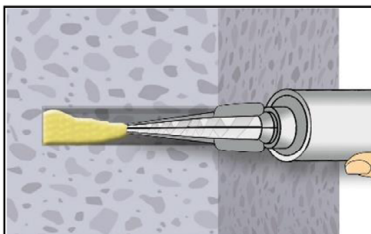

- 8a. **Injecting mortar without piston plug VS:**  
Starting at bottom of the hole and fill the hole with adhesive until the mortar level mark  $l_m$  is visible. (If necessary, a mixer nozzle extension shall be used.)  
Slowly withdraw of the static mixing nozzle avoid creating air pockets  
Observe the temperature related working time  $t_{work}$  (Annex B 6).

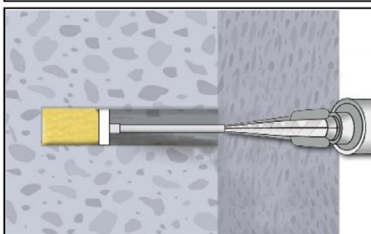

- 8b. **Injecting mortar with piston plug VS:**  
Insert piston plug to bottom of the hole and fill the hole with mortar until mortar level mark  $l_m$  is visible. (If necessary, a mixer nozzle extension shall be used.)  
During injection the piston plug is pushed out of the bore hole by the back pressure of the mortar.  
Observe the temperature related working time  $t_{work}$  (Annex B 6).

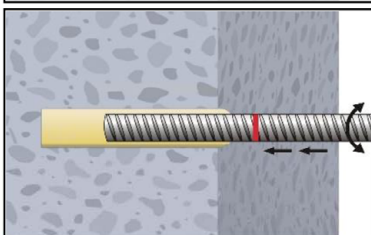

9. Insert the reinforcing bar while turning slightly up to the embedment mark.

Injection system EJOT Multifix USF / Sormat ITH-Ve for rebar connection

Intended Use

Installation instruction (continuation)

Annex B 9

### Installation instructions (continuation)

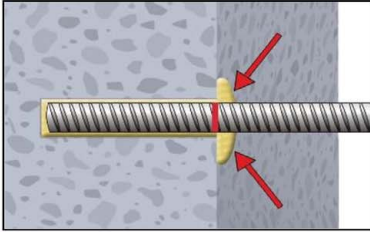

10. Annular gap between reinforcing bar and base material must be completely filled with mortar. Otherwise, the installation must be repeated starting from step 8 before the maximum working time  $t_{\text{work}}$  has expired.

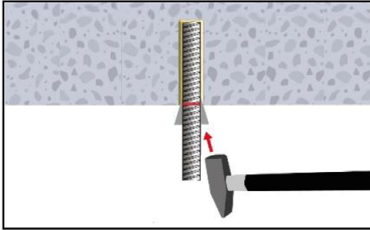

11. For application in vertical upwards direction the reinforcing bar shall be fixed (e.g. wedges).

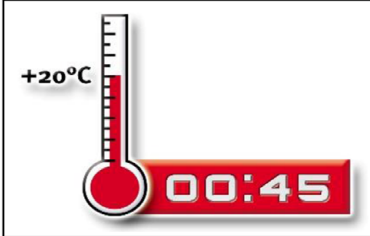

12. Temperature related curing time  $t_{\text{cure}}$  (Annex B 6) must be observed. The full load to the reinforcing bar may be applied after the full curing time  $t_{\text{cure}}$  has elapsed.

Injection system EJOT Multifix USF / Sormat ITH-Ve for rebar connection

Intended Use  
Installation instruction (continuation)

Annex B 10

<b>Table C1: Characteristic tension resistance for tension anchor ZA</b>										
Tension Anchor			M12	M16	M20	M24				
Steel, zinc plated (ZA vz)										
Characteristic tension resistance	$N_{Rk,s}$	[kN]	67	125	196	282				
Partial factor	$\gamma_{Ms,N}$	[-]	1,4							
Stainless Steel (ZA A4 or ZA HCR)										
Characteristic tension resistance	$N_{Rk,s}$	[kN]	67	125	171	247				
Partial factor	$\gamma_{Ms,N}$	[-]	1,4		1,3	1,4				
<b>Minimum anchorage length and minimum lap length under static or quasi-static loading</b>										
The minimum anchorage length $l_{b,min}$ and the minimum lap length $l_{0,min}$ according to EN 1992-1-1:2004+AC:2010 ( $l_{b,min}$ acc. to Eq. 8.6 and Eq. 8.7 and $l_{0,min}$ acc. to Eq. 8.11) shall be multiply by the amplification factor $\alpha_{lb}$ according to Table C2.										
<b>Table C2: Amplification factor <math>\alpha_{lb}</math> related to concrete class and drilling method</b>										
Concrete class		Drilling method		Bar size		Amplification factor $\alpha_{lb}$				
C12/15 to C50/60		all drilling methods		8 mm to 32 mm ZA-M12 to ZA-M24		1,0				
<b>Table C3: Reduction factor <math>k_b</math> for all drilling methods</b>										
Rebar		Concrete class								
$\phi$		C12/15	C16/20	C20/25	C25/30	C30/37	C35/45	C40/50	C45/55	C50/60
8 to 25 mm ZA-M12 to ZA-M24		1,0								
28 to 32 mm		1,0					0,92	0,86		
<b>Table C4: Design values of the ultimate bond stress <math>f_{bd,PIR}</math> in N/mm<sup>2</sup> for all drilling methods and for good conditions</b>										
$f_{bd,PIR} = k_b \cdot f_{bd}$ with $f_{bd}$ : Design value of the ultimate bond stress in N/mm <sup>2</sup> considering the concrete classes, the rebar diameter, the drilling method for good bond condition (for all other bond conditions multiply the values by $\eta_1 = 0.7$ ) and recommended partial factor $\gamma_c = 1,5$ according to EN 1992-1-1:2004+AC:2010. $k_b$ : Reduction factor according to Table C3										
Rebar		Concrete class								
$\phi$		C12/15	C16/20	C20/25	C25/30	C30/37	C35/45	C40/50	C45/55	C50/60
8 to 25 mm ZA-M12 to ZA-M24		1,6	2,0	2,3	2,7	3,0	3,4	3,7	4,0	4,3
28 to 32 mm		1,6	2,0	2,3	2,7	3,0	3,4	3,7	3,7	3,7
<b>Injection system EJOT Multifix USF / Sormat ITH-Ve for rebar connection</b>							<b>Annex C 1</b>			
<b>Performances</b> Characteristic tension resistance for tension anchor, Minimum anchorage length and minimum lap length, Amplification factor, Reduction factor and Design values of ultimate bond resistance										

### Design value of the ultimate bond stress $f_{bd,fi}$ at increased temperature for concrete classes C12/15 to C50/60, (all drilling methods):

The design value of the bond stress  $f_{bd,fi}$  at increased temperature has to be calculated by the following equation:

For working life 50 years:  $f_{bd,fi} = k_{fi}(\theta) \cdot f_{bd,PIR} \cdot \gamma_c / \gamma_{M,fi}$

mit:  $\theta \leq 243^\circ\text{C}$ :  $k_{fi}(\theta) = 18,88 \cdot e^{(\theta \cdot -0,016)} / (f_{bd,PIR} \cdot 4,3) \leq 1,0$

$\theta > 243^\circ\text{C}$ :  $k_{fi}(\theta) = 0$

$f_{bd,fi}$  Design value of the ultimate bond stress at increased temperature in  $\text{N/mm}^2$

$\theta$  Temperature in  $^\circ\text{C}$  in the mortar layer.

$k_{fi}(\theta)$  Reduction factor at increased temperature.

$f_{bd,PIR}$  Design value of the bond stress in  $\text{N/mm}^2$  in cold condition according to Table C4 considering the concrete classes, the rebar diameter, the drilling method and the bond conditions according to EN 1992-1-1:2004+AC:2010.

$\gamma_c$  = 1,5 recommended partial factor according to EN 1992-1-1:2004+AC:2010

$\gamma_{M,fi}$  = 1,0 recommended partial factor according to EN 1992-1-2:2004+AC:2008

For evidence at increased temperature the anchorage length shall be calculated according to EN 1992-1-1:2004+AC:2010 Equation 8.3 using the temperature-dependent design value of ultimate bond stress  $f_{bd,fi}$ .

### Example graph of Reduction factor $k_{fi}(\theta)$ for concrete classes C20/25 for good bond conditions:

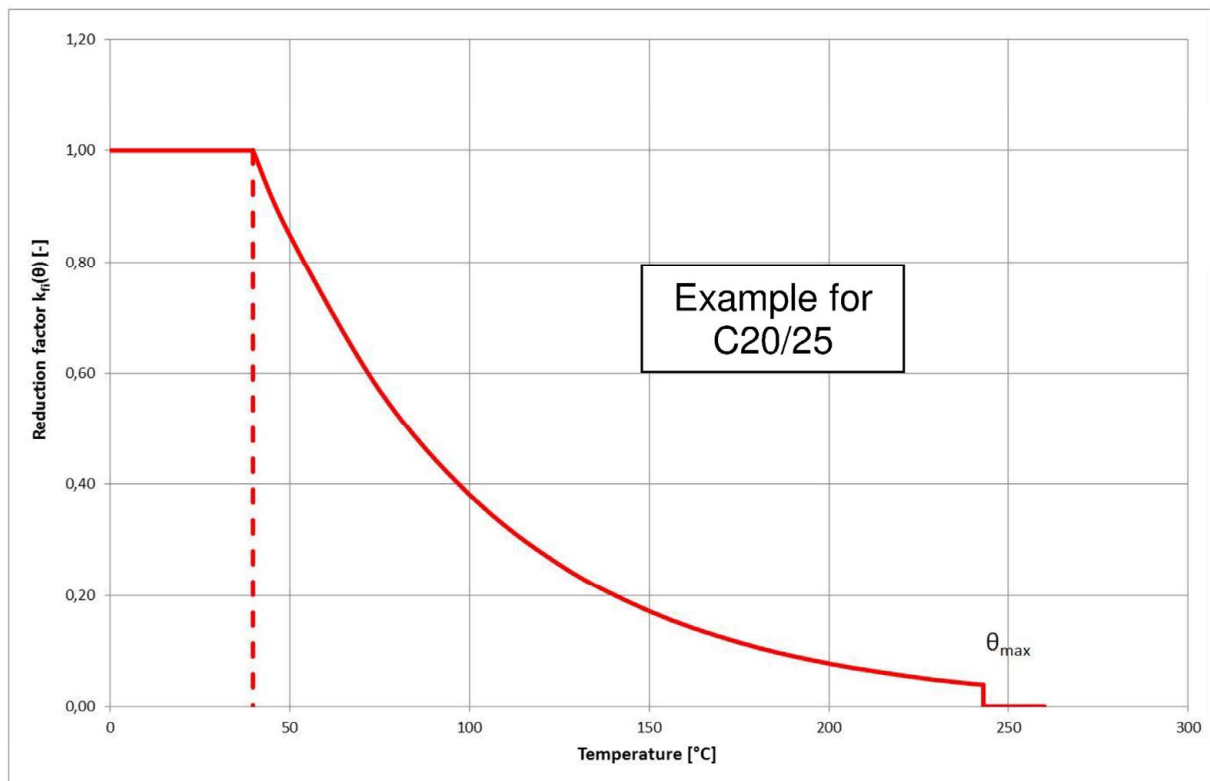

Injection system EJOT Multifix USF / Sormat ITH-Ve for rebar connection

#### Performances

Design value of ultimate bond stress at increased temperature

Annex C 2

<b>Table C5: Characteristic tension resistance for tension anchor ZA under fire exposure</b>							
<b>Tension Anchor</b>				<b>M12</b>	<b>M16</b>	<b>M20</b>	<b>M24</b>
Steel, zinc plated (ZA vz)							
Characteristic tension resistance	R30	$N_{Rk,s,fi}$	[kN]	2,3	4,0	6,3	9,0
	R60			1,7	3,0	4,7	6,8
	R90			1,5	2,6	4,1	5,9
	R120			1,1	2,0	3,1	4,5
Stainless Steel (ZA A4 or ZA HCR)							
Characteristic tension resistance	R30	$N_{Rk,s,fi}$	[kN]	3,4	6,0	9,4	13,6
	R60			2,8	5,0	7,9	11,3
	R90			2,3	4,0	6,3	9,0
	R120			1,8	3,2	5,0	7,2
<b>Injection system EJOT Multifix USF / Sormat ITH-Ve for rebar connection</b>				<b>Annex C 3</b>			
<b>Performances</b> Characteristic tension resistance for tension anchor ZA under fire exposure							